

1T7144DD | OZ Lighting module - Single

Adjustable magnetic LED light module, powered at low voltage

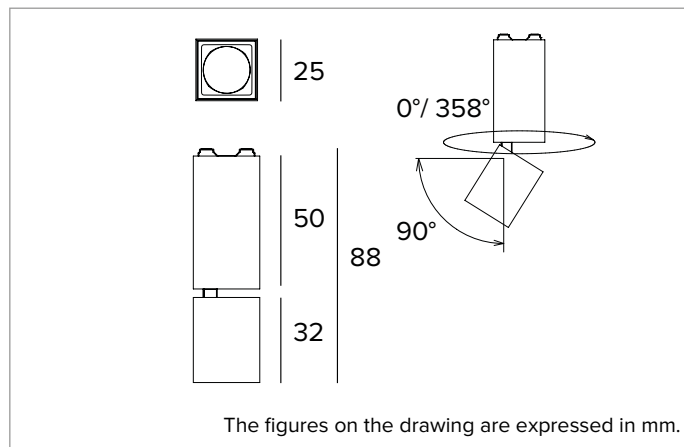

	3000K	H(m)	D(m)	Emax(lx)
	Ra90		41°	
Fixture Power	3W	1	0.75	256
Source Flux	197lm	2	1.50	64
Fixture Flux	142lm	3	2.26	28
Efficacy	51lm/W	4	3.01	16
TS1124	Imax=1300cd/klm	Imax	256cd	5
			3.76	10



SOURCE

Hugh efficiency Ra90 LED Emitter.

Energy efficiency class: G

Nominal power: 2,1W

Nominal flux: 197lm

Colour rendering index: 90

Rf: 89.3

Rg: 104.3

CCT nominal: 3000K

SDCM: 2

Lifetime (L80/B10): >50000h tq +25°C

ILLUMINOTECHNICAL CHARACTERISTICS

The medium wide flood optical system has acrylic lenses and a black polycarbonate frame. The light is suitable for installation in work environments UGR<19 (EN12464-1).

Optic: LENS

Beam angles: MWFL

Optical efficiency: 72%

Fixture flux: 142lm

Luminous efficacy: 51lm/W

Photobiological safety: Compliant with RG1 low risk group

MECHANICAL CHARACTERISTICS

Black painted die-cast aluminium body. Adjustable fixture, 25x25mm. Tiltability of the optical unit from 0° to +90° on the vertical plane and of 358° on the horizontal plane.

Colour and finish: Deep black

Dimensions: 25x25mm

Weight: 0.061Kg

Version: ADJUSTABLE DIGITAL DIMMING

Degree of protection: IP20

ELECTRICAL CHARACTERISTICS

Fixture Power: 3W

Power supply: 48Vdc

Insulation Class: CLASS 3

Class F: YES

Ambient temperature: 0°C / +25°C

INSTALLATION

Extremely rapid, versatile and simple mechanical and electrical coupling system using magnets which support the fixture on the Power Track and feed power inside the fixture on all versions.

NOTES

Digital Dimming version. 110-277Vac version available on request.

WARRANTY

5 years.

WARNING

Luminaire designed for disposal/recycling at end-of-life. Replaceable (LED only) light source by a professional. Replaceable control gear by a professional.

Due to the technological evolution of the electronic components, the data provided may be updated, and as such, confirmation must be requested during the order process.

Luminous flux and power supply have +/-10% tolerances with respect to the indicated value. tq +25°C (CIE 121).

We reserve the right to make technical changes.

Targetti Sankey S.r.l.
Via Pratese, 164
50145 Firenze - Italy
Tel: +39 055 37911
targetti.com
targetti@targetti.com

CCIAA Firenze
Share Capital:
€ 500.000,00
VAT N. (IT):
01537660480
R.E.A: FI-275656

TARGETTI